

Historical Mapping Legends

Ordnance Survey County Series 1:10,560

	Gravel Pit		Sand Pit		Other Pits
	Quarry		Shingle		Orchard
	Osiers		Reeds		Marsh
	Mixed Wood		Deciduous		Brushwood
	Fir		Furze		Rough Pasture
	Arrow denotes flow of water		Trigonometrical Station		
	Site of Antiquities		Bench Mark		
	Pump, Guide Post, Signal Post		Well, Spring, Boundary Post		
	-285 Surface Level				
	Sketched Contour		Instrumental Contour		
	Main Roads		Minor Roads		
	Sunken Road		Raised Road		
	Road over Railway		Railway over River		
	Railway over Road		Level Crossing		
	Road over River or Canal		Road over Stream		
	Road over Stream				
	County Boundary (Geographical)				
	County & Civil Parish Boundary				
	Administrative County & Civil Parish Boundary				
	County Borough Boundary (England)				
	County Burgh Boundary (Scotland)				
	Rural District Boundary				
	Civil Parish Boundary				

Ordnance Survey Plan 1:10,000

	Chalk Pit, Clay Pit or Quarry		Gravel Pit
	Sand Pit		Disused Pit or Quarry
	Refuse or Slag Heap		Lake, Loch or Pond
	Dunes		Boulders
	Coniferous Trees		Non-Coniferous Trees
	Orchard		Scrub
	Coppice		
	Bracken		Heath
	Rough Grassland		
	Marsh		Reeds
	Saltings		
	Building		Glasshouse
	Sloping Masonry		Pylon
	Electricity Transmission Line		Pole
	Cutting		Embankment
	Standard Gauge Multiple Track		
	Standard Gauge Single Track		
	Siding, Tramway or Mineral Line		
	Narrow Gauge		
	Geographical County		
	Administrative County, County Borough or County of City		
	Municipal Borough, Urban or Rural District, Burgh or District Council		
	Borough, Burgh or County Constituency Shown only when not coincident with other boundaries		
	Civil Parish Shown alternately when coincidence of boundaries occurs		
	BP, BS Boundary Post or Stone		Pol Sta Police Station
	Ch Church		PO Post Office
	CH Club House		PC Public Convenience
	F E Sta Fire Engine Station		PH Public House
	FB Foot Bridge		SB Signal Box
	Fn Fountain		Spr Spring
	GP Guide Post		TCB Telephone Call Box
	MP Mile Post		TCP Telephone Call Post
	MS Mile Stone		W Well

1:10,000 Raster Mapping

	Gravel Pit		Refuse tip or slag heap
	Rock		Rock (scattered)
	Boulders		Boulders (scattered)
	Shingle		Mud
	Sand		Sand Pit
	Slopes		Top of cliff
	General detail		Underground detail
	Overhead detail		Narrow gauge railway
	Multi-track railway		Single track railway
	County boundary (England only)		Civil, parish or community boundary
	District, Unitary, Metropolitan, London Borough boundary		Constituency boundary
	Area of wooded vegetation		Non-coniferous trees
	Non-coniferous trees (scattered)		Coniferous trees
	Coniferous trees (scattered)		Positioned tree
	Orchard		Coppice or Osiers
	Rough Grassland		Heath
	Scrub		Marsh, Salt Marsh or Reeds
	Water feature		Flow arrows
	MHW(S) Mean high water (springs)		MLW(S) Mean low water (springs)
	Telephone line (where shown)		Electricity transmission line (with poles)
	Bench mark (where shown)		Triangulation station
	Point feature (e.g. Guide Post or Mile Stone)		Pylon, flare stack or lighting tower
	Site of (antiquity)		Glasshouse
	General Building		Important Building

Envirocheck

LANDMARK INFORMATION GROUP

Historical Mapping & Photography included:

Mapping Type	Scale	Date	Pg
Lancashire And Furness	1:10,560	1848 - 1849	3
Lancashire And Furness	1:10,560	1894 - 1895	4
Lancashire And Furness	1:10,560	1912 - 1914	5
Lancashire And Furness	1:10,560	1931 - 1932	6
Lancashire And Furness	1:10,560	1938	7
Ordnance Survey Plan	1:10,000	1955 - 1956	8
Ordnance Survey Plan	1:10,000	1958	9
Ordnance Survey Plan	1:10,000	1962 - 1968	10
Ordnance Survey Plan	1:10,000	1968	11
Ordnance Survey Plan	1:10,000	1974	12
Preston	1:10,000	1976	13
Ordnance Survey Plan	1:10,000	1984 - 1988	14
Ordnance Survey Plan	1:10,000	1991	15
10K Raster Mapping	1:10,000	2001	16
10K Raster Mapping	1:10,000	2006	17
VectorMap Local	1:10,000	2021	18

Historical Map - Slice C

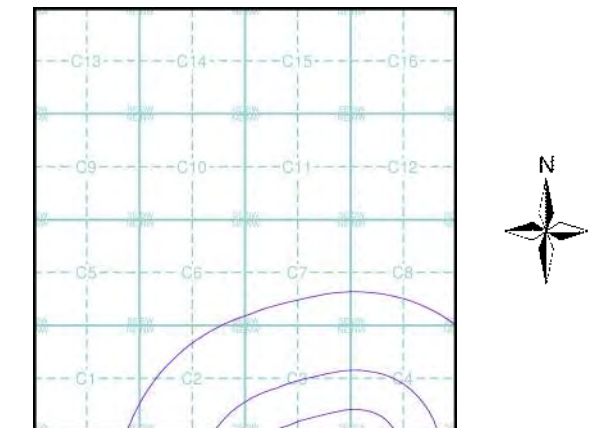

Order Details

Order Number: 289775268_1_1
 Customer Ref: WIE11556-107
 National Grid Reference: 355290, 425700
 Slice: C
 Site Area (Ha): 61.13
 Search Buffer (m): 1000

Site Details

Site at 355440, 424740

Landmark
 INFORMATION GROUP

Tel: 0844 844 9952
 Fax: 0844 844 9951
 Web: www.envirocheck.co.uk

Russian Military Mapping Legends

1:5,000 and 1:10,000 mapping

a. Not drawn to scale b. Drawn to scale

	Government and Administrative Buildings		Military and Industrial Buildings
	Military and Communication Areas		Subway Entrance
	Fireproof Building		Prominent Fireproof Building
	Non-fireproof Building		Non-fireproof Building (non-dwelling)
	Factory, mill, and flour mill, with chimneys		Factory, mill, and flour mill, without chimneys
	Power Station, drawn to scale		Hydroelectric Power Station
	Radio Station, drawn to scale		Telephone Station, drawn to scale
	Abandoned Open-pit Mine or Quarry		Open-pit Salt Mine
	Pit		Oil Deposit or Well
	Oil Seepage		Natural Gas Tank
	Tailings Pile		Fuel Storage Tanks
	Bench Mark		Drill Hole
	Burial Mound		Triangulation Point on Burial Mound
	Single-track Railroad		Double-track Railroad
	Small Bridge		Tunnel
	Pipe (Culvert)		Railroad and Station Building
	Coniferous Forest		Deciduous Forest
	Mixed Forest		Lawns
	Citrus Orchard		Wet Ground
	Scattered Vegetation		

243,8 Values for prominent elevations
186.0 Numbers for spot elevations, depth soundings, contour lines, etc.
0,2 Velocity of the current, width of river bed, depth of river
180/12 Fractional terms: length and capacity of bridges; depth of fords and condition of the river bottom; height of forest and the diameter of trees

Russian Alphabet (For reference and phonetic interpretation of map text)

А а (A)	З з (Z)	П п (P)	Ч ч (CH)
Б б (B)	И и (I)	Р р (R)	Ш ш (SH)
В в (V)	Й й (Y)	С с (S)	Щ щ (SHCH)
Г г (G)	К к (K)	Т т (T)	Ъ (-)
Д д (D)	Л л (L)	У у (U)	Ы (Y)
Е е (E)	М м (M)	Ф ф (F)	Ь (')
Ё ё (YO)	Н н (N)	Х х (KH)	Э э (E)
Ж ж (ZH)	О о (O)	Ц ц (TS)	Ю ю (YU or IU)
			Я я (YA or IA)

1:25,000 mapping

a. Not drawn to scale b. Drawn to scale

	Government and Administrative Buildings		Military and Industrial Buildings
	Military and Communication Areas		Subway Entrance
	Partly Demolished Buildings		Demolished Buildings
	Built-Up Area with Fireproof Buildings Predominant		Built-Up Area with Non-Fireproof Buildings Predominant
	Individual Fireproof Building		Prominent Industrial Building
	Individual Dwelling, Fireproof		Ruins of an Individual Dwelling
	Factory or Mill Chimney		Factory or Mill with Chimney
	Factory or Mill without Chimney		Mine or Open Pit Mine
	Operating Shaft or Mine		Non-Operating Shaft or Mine
	Salt Mine		Tailings Pile
	Pit		Stone Quarry
	Gas Pump or Service Station		Fuel Storage or Natural Gas Tank
	Oil or Natural Gas Derrick		Small Hydroelectric Power Station
	Power Station		Transformer Station
	Cemetery		Burial Mound (height in metres)
	Triangulation Point on Burial Mound		Triangulation Point
	Bench Mark		Bench Mark (monumented)
	Telegraph Office		Telephone Station
	Radio Station		Radio Tower
	Airfield or Seaplane Base		Landing Strip
	Cut		Fill
	Km Post		Plantings
	Telegraph/Telephone Lines		Main Highway
	Highway under Construction		Improved Dirt Road (former truck road)
	Small Bridge		Pipe (Culvert)
	Tunnel		Dismantled Railroad
	Double-track Railroad with First Class Station		Railroad Under Construction
	Shore Embankment		River or Ditch with Embankment
	Water Reservoir or Rain Water Pit		Spring
	Well		Isobath with value
	Heavy (Index) Contour Line		Contour Line and Value
	Half Contour Line		Spot Elevation Value
	Coniferous		Deciduous
	Mixed		Scrub

Key to Numbers on Mapping

SD52NE_Preston

No.	Description
12	Factory (Metal Works)

SD52NW_Preston

No.	Description
47	Railway Station (Freight)

Envirocheck

LANDMARK INFORMATION GROUP

Historical Mapping & Photography included:

Mapping Type	Scale	Date	Pg
Lancashire And Furness	1:10,560	1848 - 1849	3
Lancashire And Furness	1:10,560	1894 - 1895	4
Lancashire And Furness	1:10,560	1912 - 1914	5
Lancashire And Furness	1:10,560	1931 - 1932	6
Lancashire And Furness	1:10,560	1938	7
Ordnance Survey Plan	1:10,000	1955 - 1956	8
Ordnance Survey Plan	1:10,000	1958	9
Ordnance Survey Plan	1:10,000	1962 - 1968	10
Ordnance Survey Plan	1:10,000	1968	11
Ordnance Survey Plan	1:10,000	1974	12
Preston	1:10,000	1976	13
Ordnance Survey Plan	1:10,000	1984 - 1988	14
Ordnance Survey Plan	1:10,000	1991	15
10K Raster Mapping	1:10,000	2001	16
10K Raster Mapping	1:10,000	2006	17
VectorMap Local	1:10,000	2021	18

Russian Map - Slice C

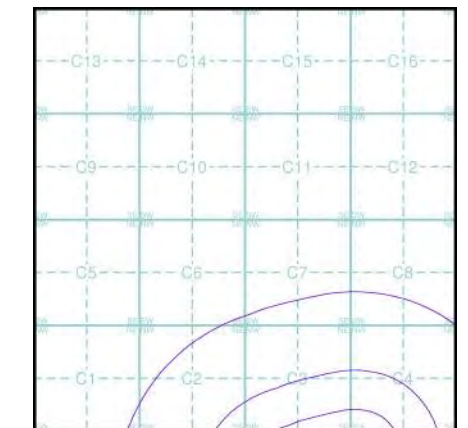

Order Details

Order Number: 289775268_1_1
 Customer Ref: WIE11556-107
 National Grid Reference: 355290, 425700
 Slice: C
 Site Area (Ha): 61.13
 Search Buffer (m): 1000

Site Details

Site at 355440, 424740

Landmark
 INFORMATION GROUP

Tel: 0844 844 9952
 Fax: 0844 844 9951
 Web: www.envirocheck.co.uk

Lancashire And Furness

Published 1848 - 1849

Source map scale - 1:10,560

The historical maps shown were reproduced from maps predominantly held at the scale adopted for England, Wales and Scotland in the 1840's. In 1854 the 1:2,500 scale was adopted for mapping urban areas; these maps were used to update the 1:10,560 maps. The published date given therefore is often some years later than the surveyed date. Before 1938, all OS maps were based on the Cassini Projection, with independent surveys of a single county or group of counties, giving rise to significant inaccuracies in outlying areas. In the late 1940's, a Provisional Edition was produced, which updated the 1:10,560 mapping from a number of sources. The maps appear unfinished - with all military camps and other strategic sites removed. These maps were initially overprinted with the National Grid. In 1970, the first 1:10,000 maps were produced using the Transverse Mercator Projection. The revision process continued until recently, with new editions appearing every 10 years or so for urban areas.

Map Name(s) and Date(s)

06100	1849	1:10,560
06900	1848	1:10,560

Historical Map - Slice C

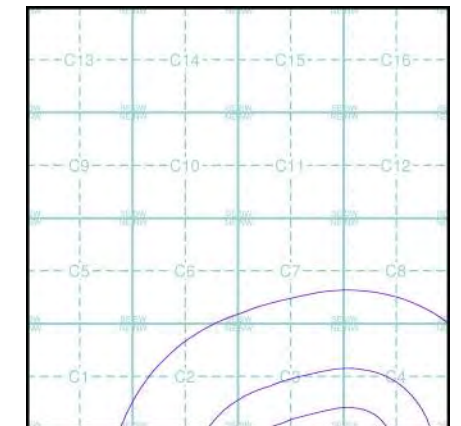

Order Details

Order Number: 289775268_1_1
 Customer Ref: WIE11556-107
 National Grid Reference: 355290, 425700
 Slice: C
 Site Area (Ha): 61.13
 Search Buffer (m): 1000

Site Details

Site at 355440, 424740

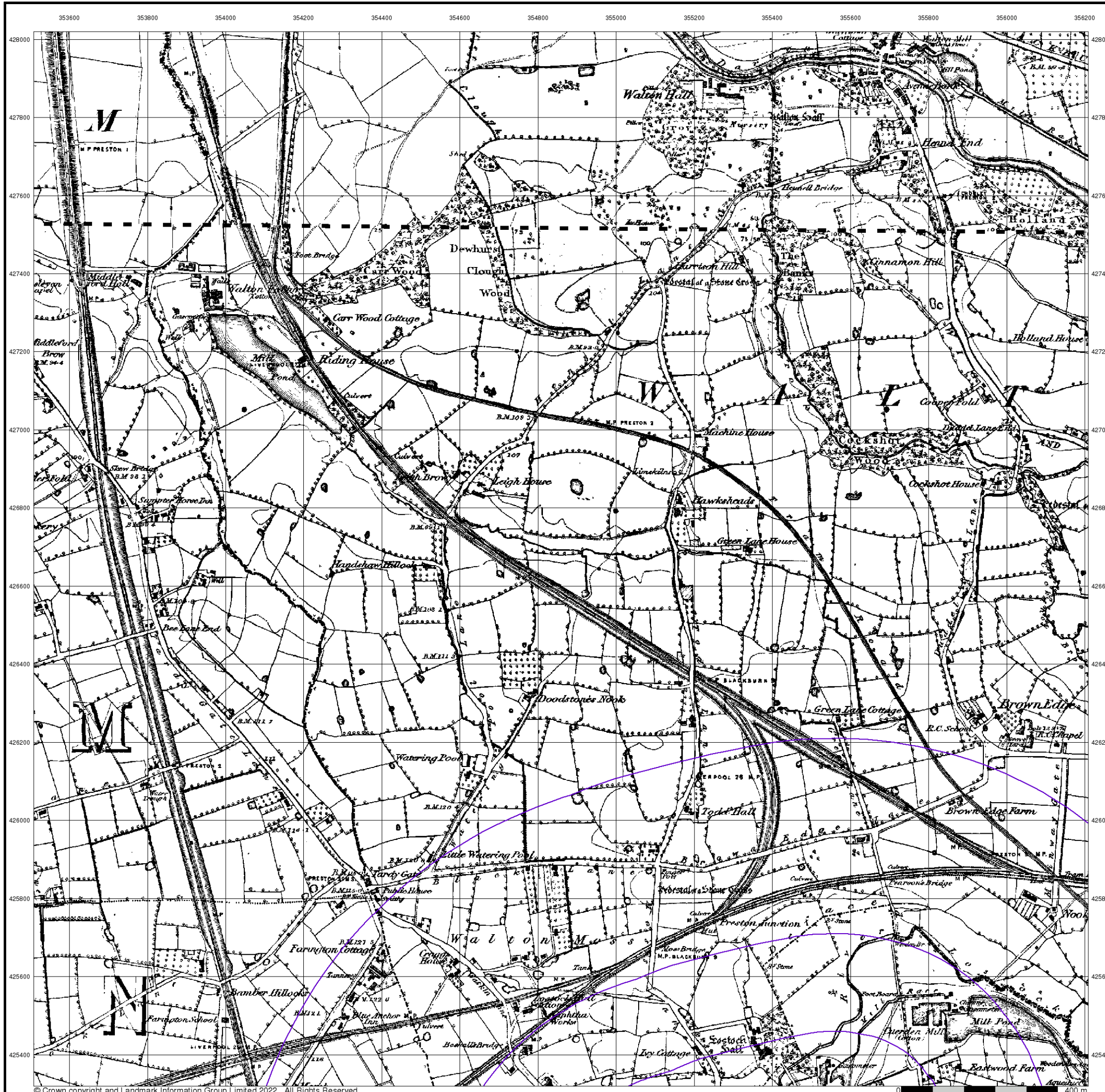

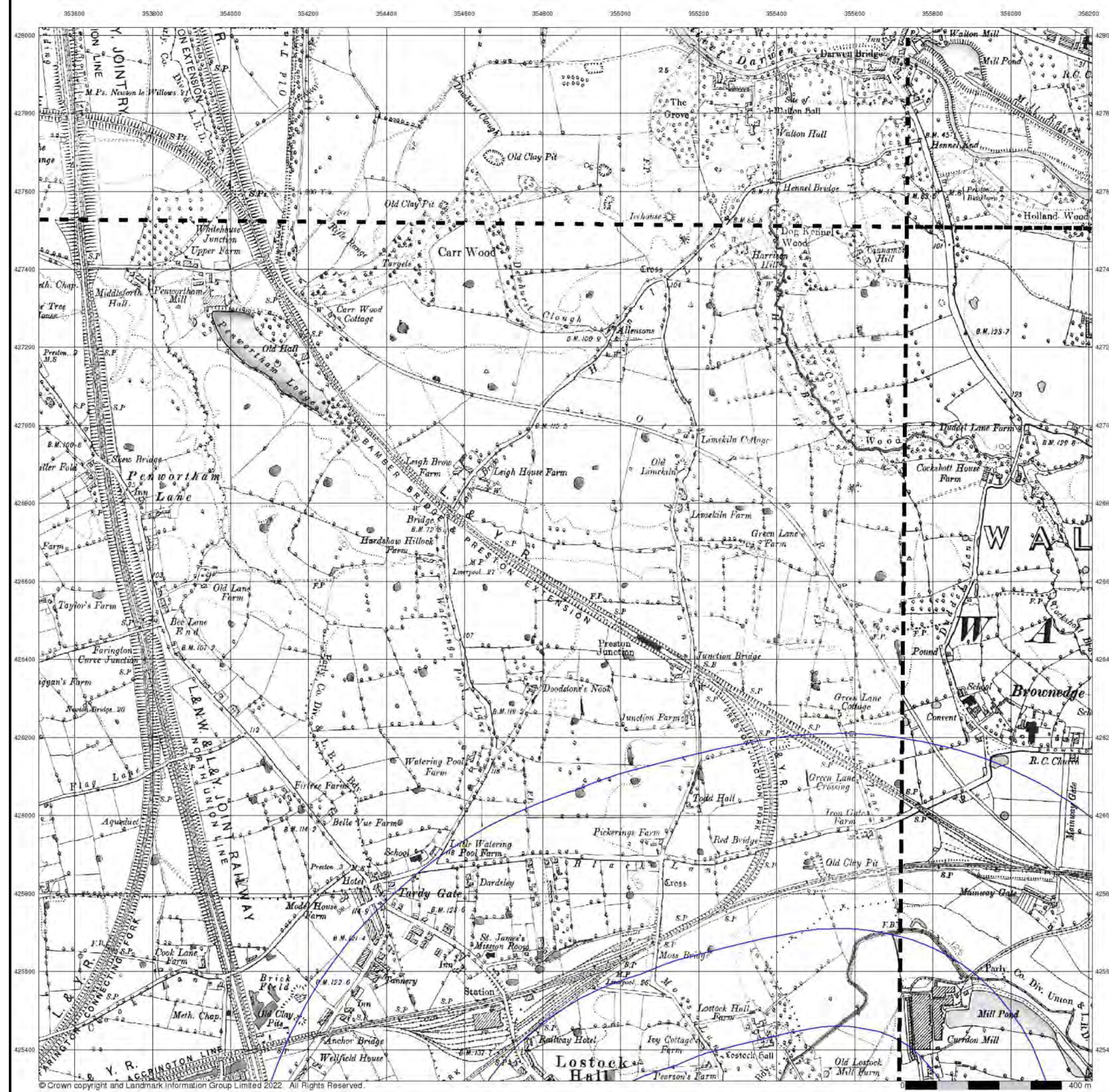

Lancashire And Furness

Published 1894 - 1895

Source map scale - 1:10,560

The historical maps shown were reproduced from maps predominantly held at the scale adopted for England, Wales and Scotland in the 1840's. In 1854 the 1:2,500 scale was adopted for mapping urban areas; these maps were used to update the 1:10,560 maps. The published date given therefore is often some years later than the surveyed date. Before 1938, all OS maps were based on the Cassini Projection, with independent surveys of a single county or group of counties, giving rise to significant inaccuracies in outlying areas. In the late 1940's, a Provisional Edition was produced, which updated the 1:10,560 mapping from a number of sources. The maps appear unfinished - with all military camps and other strategic sites removed. These maps were initially overprinted with the National Grid. In 1970, the first 1:10,000 maps were produced using the Transverse Mercator Projection. The revision process continued until recently, with new editions appearing every 10 years or so for urban areas.

Map Name(s) and Date(s)

061SW 1895 1:10,560	061SE 1895 1:10,560
069NW 1894 1:10,560	069NE 1895 1:10,560

Historical Map - Slice C

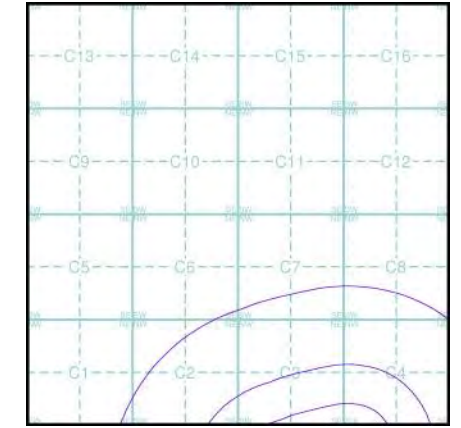

Order Details

Order Number: 289775268_1_1
 Customer Ref: WIE11556-107
 National Grid Reference: 355290, 425700
 Slice: C
 Site Area (Ha): 61.13
 Search Buffer (m): 1000

Site Details

Site at 355440, 424740

Lancashire And Furness

Published 1912 - 1914

Source map scale - 1:10,560

The historical maps shown were reproduced from maps predominantly held at the scale adopted for England, Wales and Scotland in the 1840's. In 1854 the 1:2,500 scale was adopted for mapping urban areas; these maps were used to update the 1:10,560 maps. The published date given therefore is often some years later than the surveyed date. Before 1938, all OS maps were based on the Cassini Projection, with independent surveys of a single county or group of counties, giving rise to significant inaccuracies in outlying areas. In the late 1940's, a Provisional Edition was produced, which updated the 1:10,560 mapping from a number of sources. The maps appear unfinished - with all military camps and other strategic sites removed. These maps were initially overprinted with the National Grid. In 1970, the first 1:10,000 maps were produced using the Transverse Mercator Projection. The revision process continued until recently, with new editions appearing every 10 years or so for urban areas.

Map Name(s) and Date(s)

061SW 1913 1:10,560	061SE 1913 1:10,560
069NW 1912 1:10,560	069NE 1914 1:10,560

Historical Map - Slice C

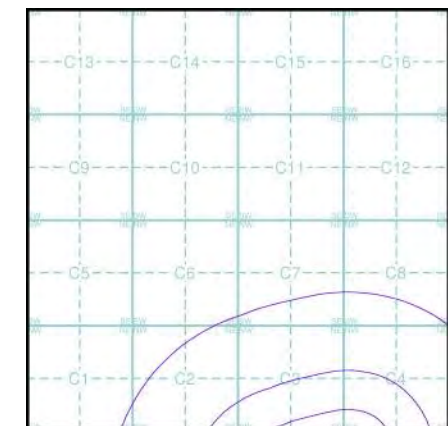

Order Details

Order Number: 289775268_1_1
 Customer Ref: WIE11556-107
 National Grid Reference: 355290, 425700
 Slice: C
 Site Area (Ha): 61.13
 Search Buffer (m): 1000

Site Details

Site at 355440, 424740

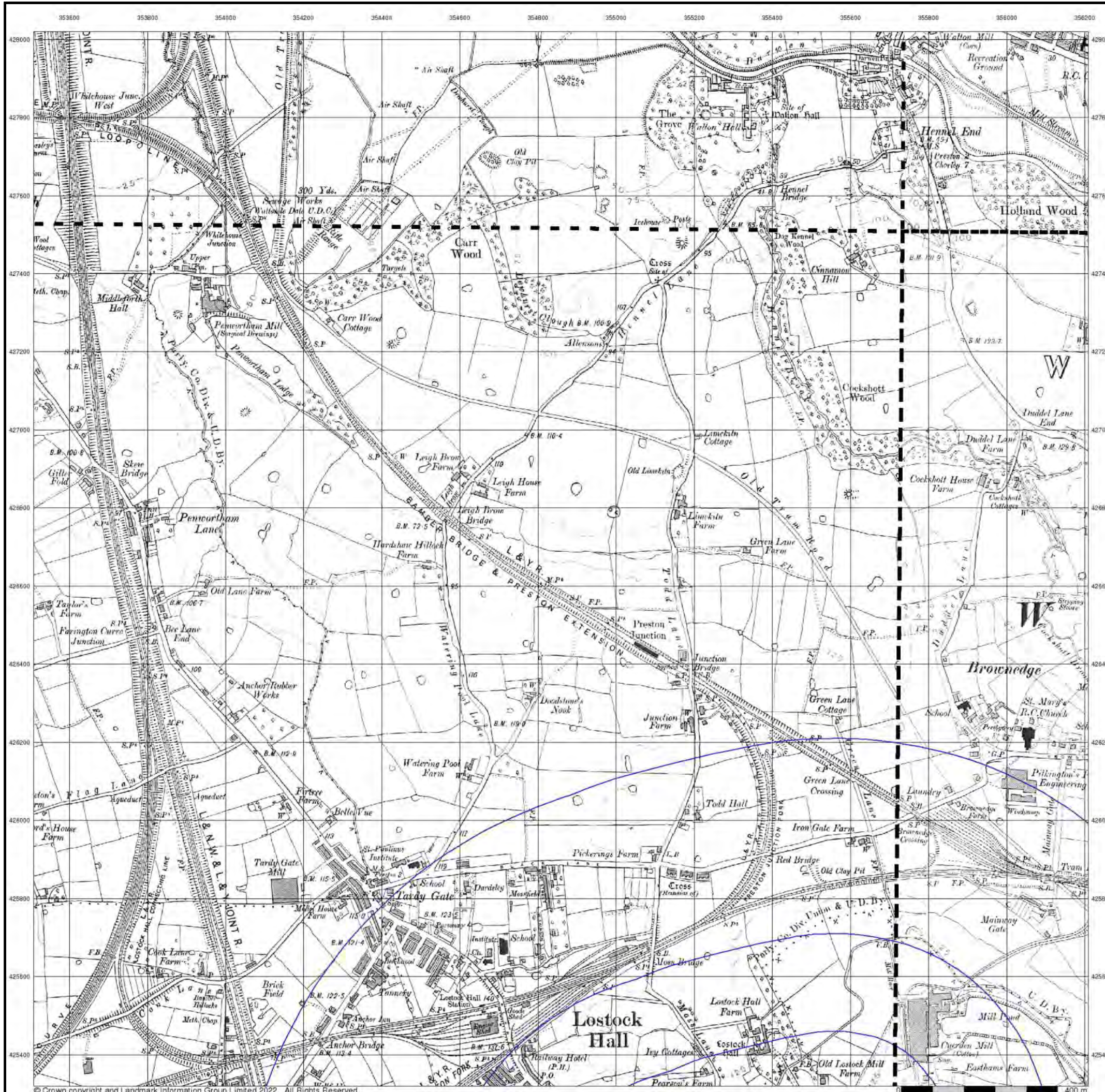

Lancashire And Furness

Published 1931 - 1932

Source map scale - 1:10,560

The historical maps shown were reproduced from maps predominantly held at the scale adopted for England, Wales and Scotland in the 1840's. In 1854 the 1:2,500 scale was adopted for mapping urban areas; these maps were used to update the 1:10,560 maps. The published date given therefore is often some years later than the surveyed date. Before 1938, all OS maps were based on the Cassini Projection, with independent surveys of a single county or group of counties, giving rise to significant inaccuracies in outlying areas. In the late 1940's, a Provisional Edition was produced, which updated the 1:10,560 mapping from a number of sources. The maps appear unfinished - with all military camps and other strategic sites removed. These maps were initially overprinted with the National Grid. In 1970, the first 1:10,000 maps were produced using the Transverse Mercator Projection. The revision process continued until recently, with new editions appearing every 10 years or so for urban areas.

Map Name(s) and Date(s)

061SW 1932 1:10,560	061SE 1932 1:10,560
069NW 1931 1:10,560	069NE 1932 1:10,560

Historical Map - Slice C

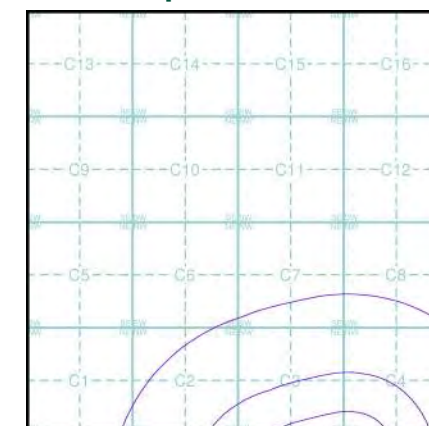

Order Details

Order Number: 289775268_1_1
 Customer Ref: WIE11556-107
 National Grid Reference: 355290, 425700
 Slice: C
 Site Area (Ha): 61.13
 Search Buffer (m): 1000

Site Details

Site at 355440, 424740

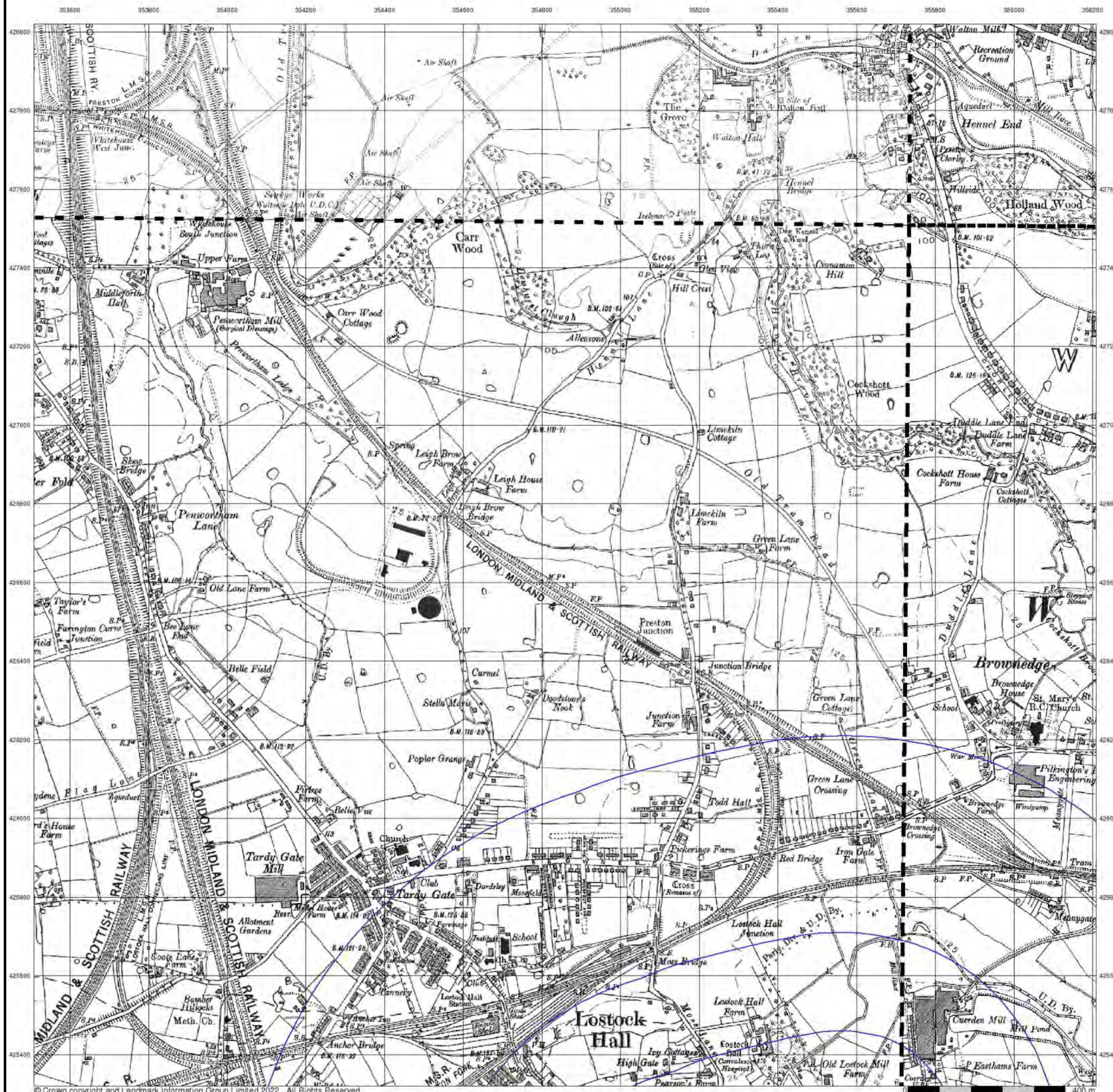

Lancashire And Furness

Published 1938

Source map scale - 1:10,560

The historical maps shown were reproduced from maps predominantly held at the scale adopted for England, Wales and Scotland in the 1840's. In 1854 the 1:2,500 scale was adopted for mapping urban areas; these maps were used to update the 1:10,560 maps. The published date given therefore is often some years later than the surveyed date. Before 1938, all OS maps were based on the Cassini Projection, with independent surveys of a single county or group of counties, giving rise to significant inaccuracies in outlying areas. In the late 1940's, a Provisional Edition was produced, which updated the 1:10,560 mapping from a number of sources. The maps appear unfinished - with all military camps and other strategic sites removed. These maps were initially overprinted with the National Grid. In 1970, the first 1:10,000 maps were produced using the Transverse Mercator Projection. The revision process continued until recently, with new editions appearing every 10 years or so for urban areas.

Map Name(s) and Date(s)

061SW 1938 1:10,560	061SE 1938 1:10,560
069NW 1938 1:10,560	069NE 1938 1:10,560

Historical Map - Slice C

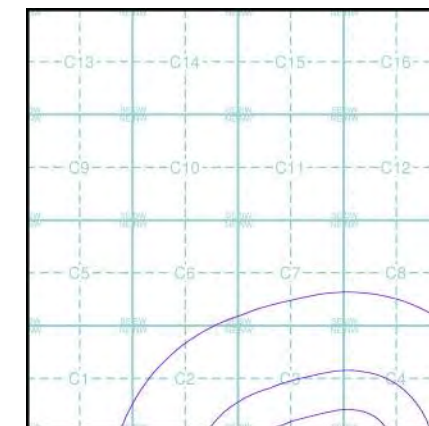

Order Details

Order Number: 289775268_1_1
 Customer Ref: WIE11556-107
 National Grid Reference: 355290, 425700
 Slice: C
 Site Area (Ha): 61.13
 Search Buffer (m): 1000

Site Details

Site at 355440, 424740

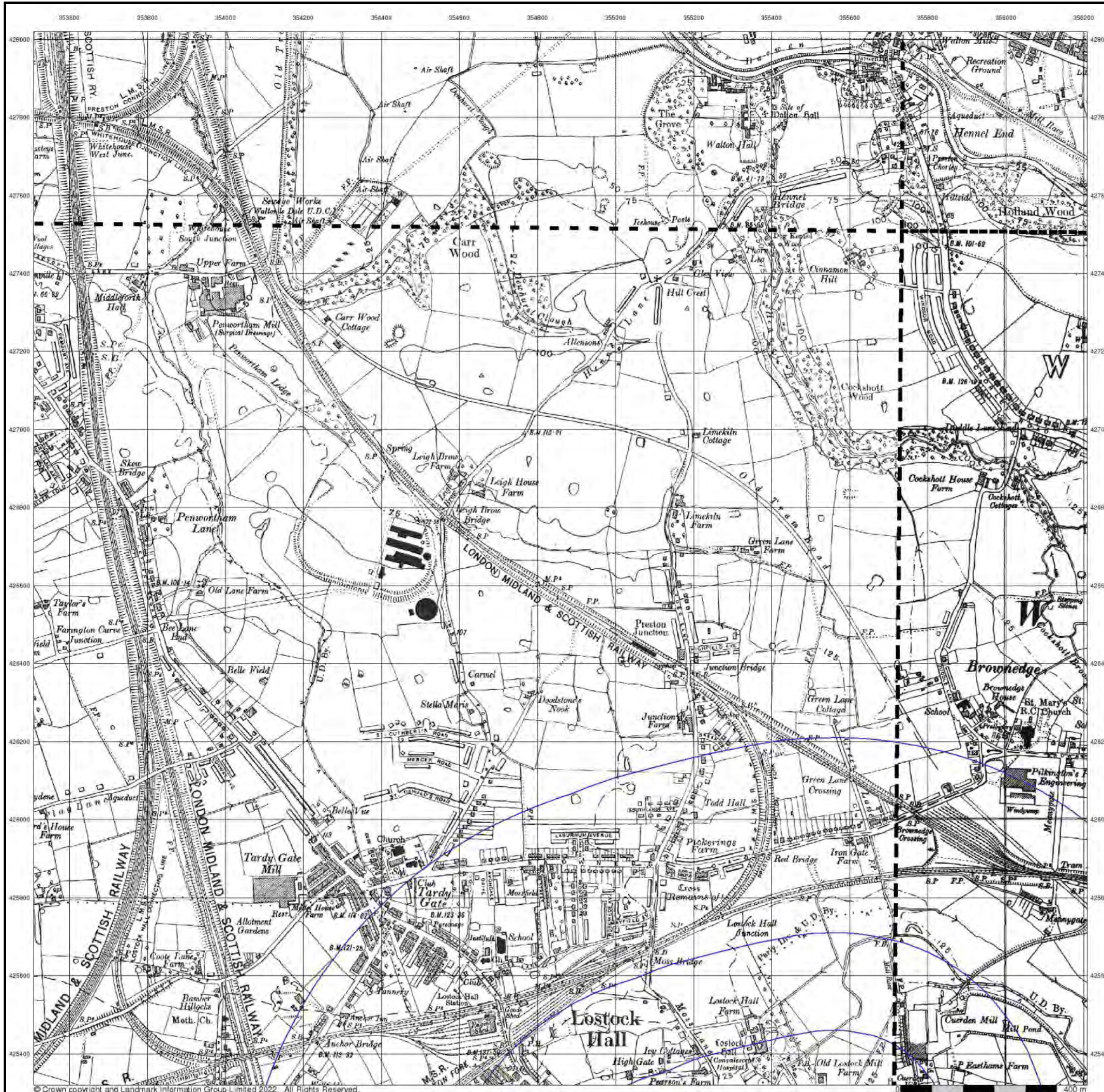

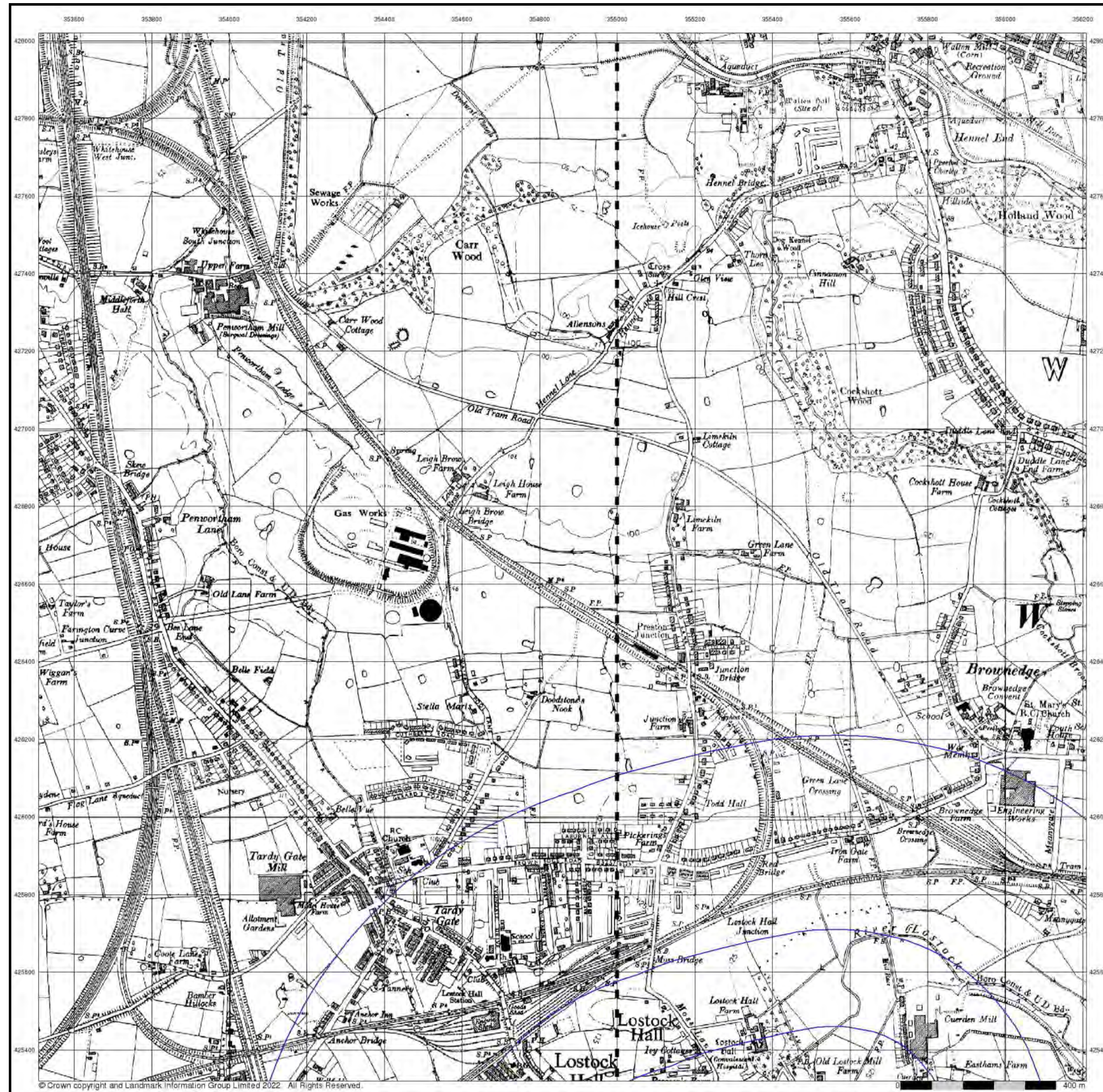

© Crown copyright and Landmark Information Group Limited 2022. All Rights Reserved.

Envirocheck

LANDMARK INFORMATION GROUP

Ordnance Survey Plan

Published 1955 - 1956

Source map scale - 1:10,000

The historical maps shown were reproduced from maps predominantly held at the scale adopted for England, Wales and Scotland in the 1840's. In 1854 the 1:2,500 scale was adopted for mapping urban areas; these maps were used to update the 1:10,560 maps. The published date given therefore is often some years later than the surveyed date. Before 1938, all OS maps were based on the Cassini Projection, with independent surveys of a single county or group of counties, giving rise to significant inaccuracies in outlying areas. In the late 1940's, a Provisional Edition was produced, which updated the 1:10,560 mapping from a number of sources. The maps appear unfinished - with all military camps and other strategic sites removed. These maps were initially overprinted with the National Grid. In 1970, the first 1:10,000 maps were produced using the Transverse Mercator Projection. The revision process continued until recently, with new editions appearing every 10 years or so for urban areas.

Map Name(s) and Date(s)

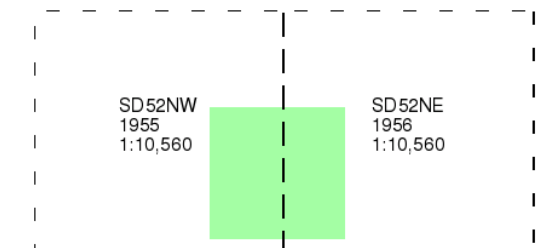

Historical Map - Slice C

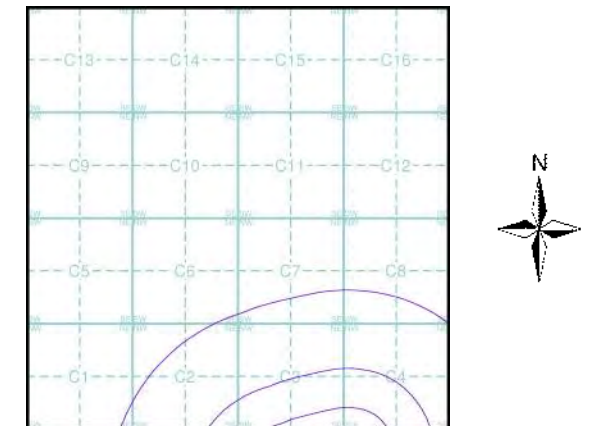

Order Details

Order Number: 289775268_1_1
 Customer Ref: WIE11556-107
 National Grid Reference: 355290, 425700
 Slice: C
 Site Area (Ha): 61.13
 Search Buffer (m): 1000

Site Details

Site at 355440, 424740

Landmark
 INFORMATION GROUP

Tel: 0844 844 9952
 Fax: 0844 844 9951
 Web: www.envirocheck.co.uk

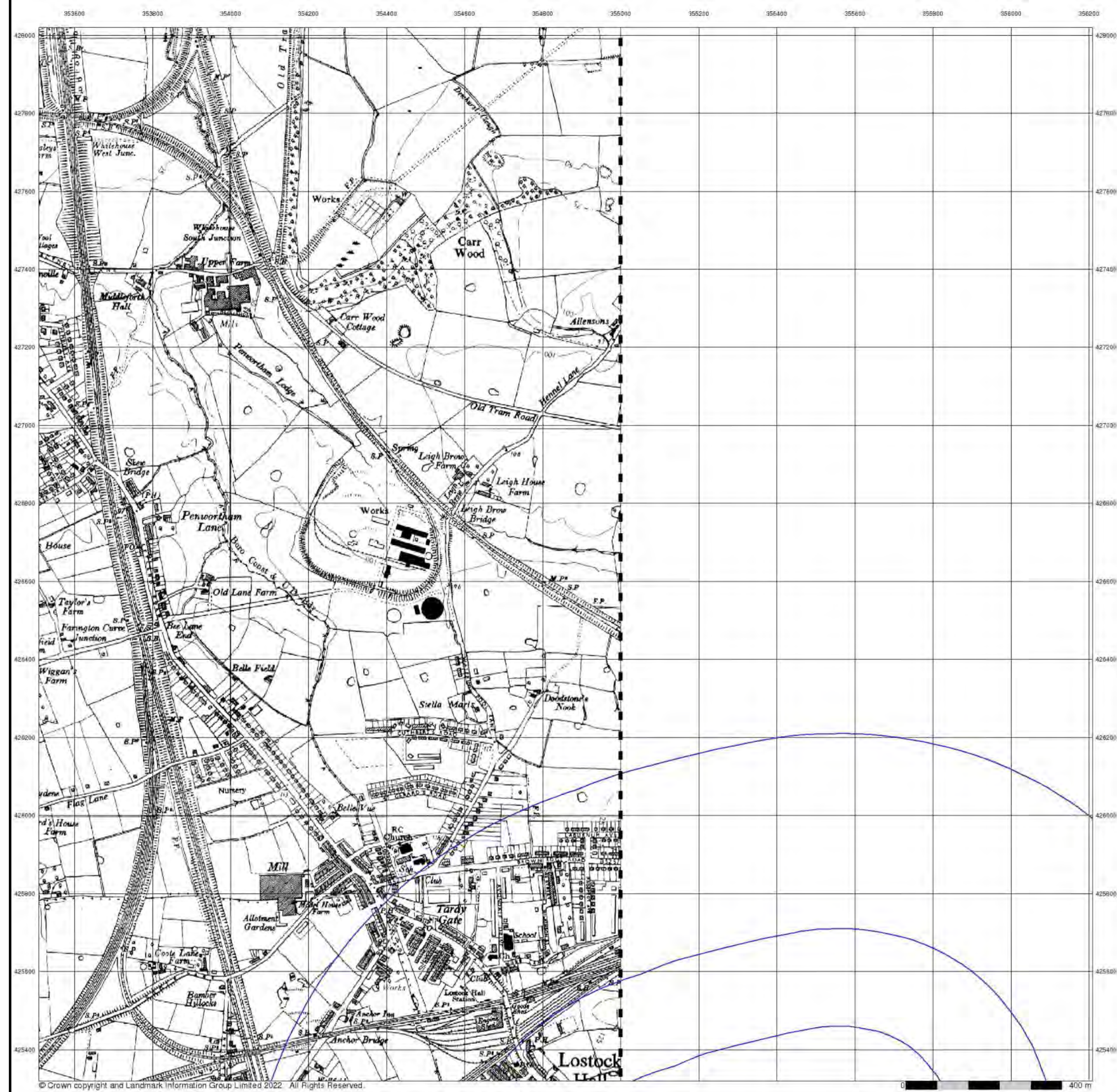

Ordnance Survey Plan

Published 1958

Source map scale - 1:10,000

The historical maps shown were reproduced from maps predominantly held at the scale adopted for England, Wales and Scotland in the 1840's. In 1854 the 1:2,500 scale was adopted for mapping urban areas; these maps were used to update the 1:10,560 maps. The published date given therefore is often some years later than the surveyed date. Before 1938, all OS maps were based on the Cassini Projection, with independent surveys of a single county or group of counties, giving rise to significant inaccuracies in outlying areas. In the late 1940's, a Provisional Edition was produced, which updated the 1:10,560 mapping from a number of sources. The maps appear unfinished - with all military camps and other strategic sites removed. These maps were initially overprinted with the National Grid. In 1970, the first 1:10,000 maps were produced using the Transverse Mercator Projection. The revision process continued until recently, with new editions appearing every 10 years or so for urban areas.

Map Name(s) and Date(s)

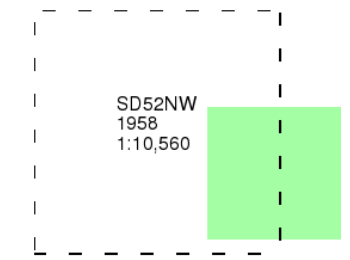

Historical Map - Slice C

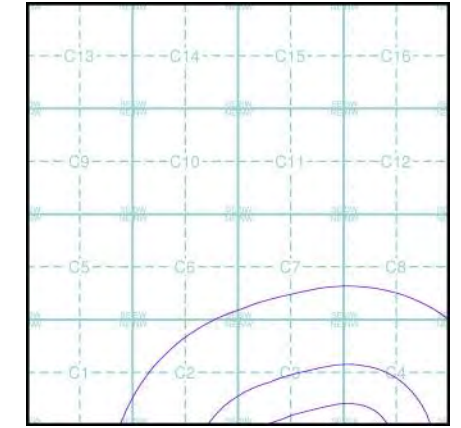

Order Details

Order Number: 289775268_1_1
 Customer Ref: WIE11556-107
 National Grid Reference: 355290, 425700
 Slice: C
 Site Area (Ha): 61.13
 Search Buffer (m): 1000

Site Details

Site at 355440, 424740



© Crown copyright and Landmark Information Group Limited 2022. All Rights Reserved.

Envirocheck[®]

LANDMARK INFORMATION GROUP[®]

Ordnance Survey Plan
Published 1962 - 1968
Source map scale - 1:10,000

The historical maps shown were reproduced from maps predominantly held at the scale adopted for England, Wales and Scotland in the 1840's. In 1854 the 1:2,500 scale was adopted for mapping urban areas; these maps were used to update the 1:10,560 maps. The published date given therefore is often some years later than the surveyed date. Before 1938, all OS maps were based on the Cassini Projection, with independent surveys of a single county or group of counties, giving rise to significant inaccuracies in outlying areas. In the late 1940's, a Provisional Edition was produced, which updated the 1:10,560 mapping from a number of sources. The maps appear unfinished - with all military camps and other strategic sites removed. These maps were initially overprinted with the National Grid. In 1970, the first 1:10,000 maps were produced using the Transverse Mercator Projection. The revision process continued until recently, with new editions appearing every 10 years or so for urban areas.

Map Name(s) and Date(s)

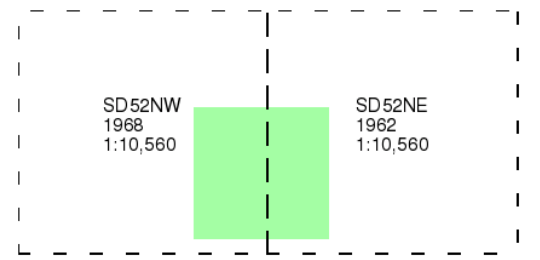

Historical Map - Slice C

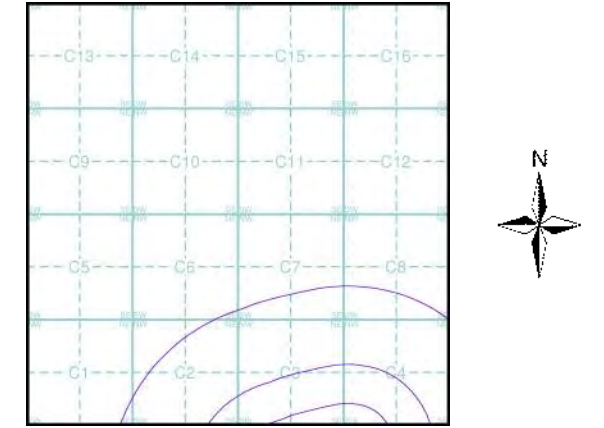

Order Details
 Order Number: 289775268_1_1
 Customer Ref: WIE11556-107
 National Grid Reference: 355290, 425700
 Slice: C
 Site Area (Ha): 61.13
 Search Buffer (m): 1000

Site Details
 Site at 355440, 424740

Landmark[®]
 INFORMATION GROUP

Tel: 0844 844 9952
 Fax: 0844 844 9951
 Web: www.envirocheck.co.uk



© Crown copyright and Landmark Information Group Limited 2022. All Rights Reserved.

Ordnance Survey Plan Published 1968 Source map scale - 1:10,000

The historical maps shown were reproduced from maps predominantly held at the scale adopted for England, Wales and Scotland in the 1840's. In 1854 the 1:2,500 scale was adopted for mapping urban areas; these maps were used to update the 1:10,560 maps. The published date given therefore is often some years later than the surveyed date. Before 1938, all OS maps were based on the Cassini Projection, with independent surveys of a single county or group of counties, giving rise to significant inaccuracies in outlying areas. In the late 1940's, a Provisional Edition was produced, which updated the 1:10,560 mapping from a number of sources. The maps appear unfinished - with all military camps and other strategic sites removed. These maps were initially overprinted with the National Grid. In 1970, the first 1:10,000 maps were produced using the Transverse Mercator Projection. The revision process continued until recently, with new editions appearing every 10 years or so for urban areas.

Map Name(s) and Date(s)

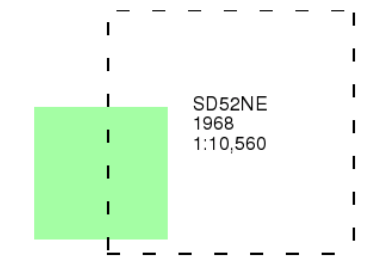

Historical Map - Slice C

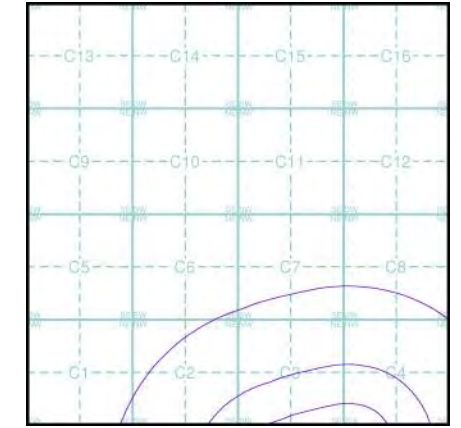

Order Details

Order Number: 289775268_1_1
 Customer Ref: WIE11556-107
 National Grid Reference: 355290, 425700
 Slice: C
 Site Area (Ha): 61.13
 Search Buffer (m): 1000

Site Details

Site at 355440, 424740



© Crown copyright and Landmark Information Group Limited 2022. All Rights Reserved.

Envirocheck®

LANDMARK INFORMATION GROUP®

Ordnance Survey Plan

Published 1974

Source map scale - 1:10,000

The historical maps shown were reproduced from maps predominantly held at the scale adopted for England, Wales and Scotland in the 1840's. In 1854 the 1:2,500 scale was adopted for mapping urban areas; these maps were used to update the 1:10,560 maps. The published date given therefore is often some years later than the surveyed date. Before 1938, all OS maps were based on the Cassini Projection, with independent surveys of a single county or group of counties, giving rise to significant inaccuracies in outlying areas. In the late 1940's, a Provisional Edition was produced, which updated the 1:10,560 mapping from a number of sources. The maps appear unfinished - with all military camps and other strategic sites removed. These maps were initially overlaid with the National Grid. In 1970, the first 1:10,000 maps were produced using the Transverse Mercator Projection. The revision process continued until recently, with new editions appearing every 10 years or so for urban areas.

Map Name(s) and Date(s)

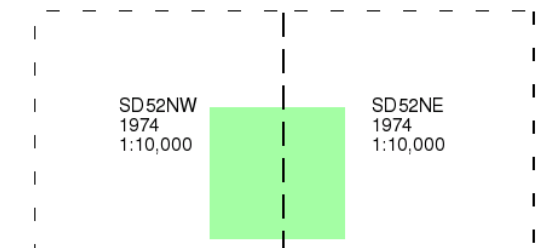

Historical Map - Slice C

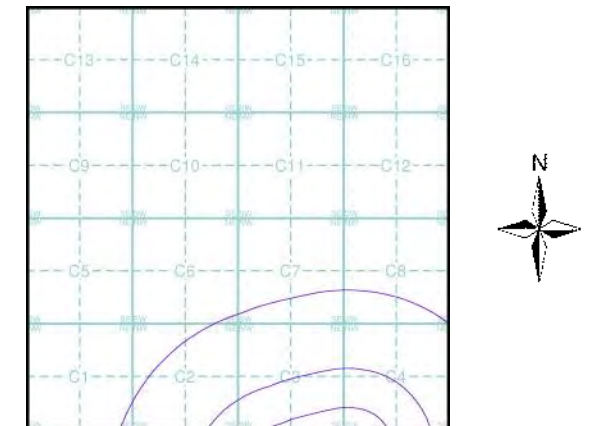

Order Details

Order Number: 289775268_1_1
 Customer Ref: WIE11556-107
 National Grid Reference: 355290, 425700
 Slice: C
 Site Area (Ha): 61.13
 Search Buffer (m): 1000

Site Details

Site at 355440, 424740

Landmark
 INFORMATION GROUP

Tel: 0844 844 9952
 Fax: 0844 844 9951
 Web: www.envirocheck.co.uk



© Copyright Landmark Information Group Ltd. All Rights Reserved.

Envirocheck®

LANDMARK INFORMATION GROUP®

Preston

Published 1976

Source map scale - 1:10,000

These maps were produced by the Russian military during the Cold War between 1950 and 1997, and cover 103 towns and cities throughout the U.K. The maps are produced at 1:25,000, 1:10,000 and 1:5,000 scale, and show detailed land use, with colour-coded areas for development, green areas, and non-developed areas. Buildings are coloured black and important building uses (such as hospitals, post offices, factories etc.) are numbered, with a numbered key describing their use.

They were produced by the Russians for the benefit of navigation, as well as strategic military sites and transport hubs, for use if they were to have invaded the U.K. The detailed information provided indicates that the areas were surveyed using land-based personnel, on the ground, in the cities that are mapped.

Map Name(s) and Date(s)

SD52NW 1976 1:10,000	SD52NE 1976 1:10,000
----------------------------	----------------------------

Russian Map - Slice C

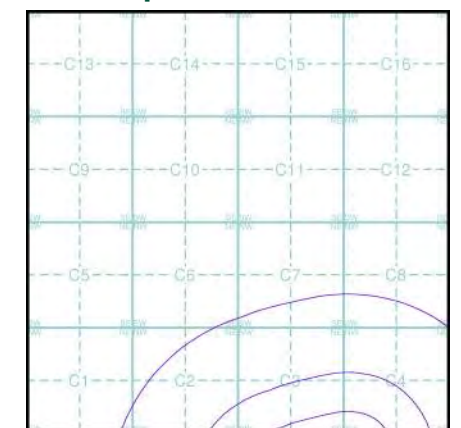

Order Details

Order Number: 289775268_1_1
 Customer Ref: WIE11556-107
 National Grid Reference: 355290, 425700
 Slice: C
 Site Area (Ha): 61.13
 Search Buffer (m): 1000

Site Details

Site at 355440, 424740

Landmark
 INFORMATION GROUP

Tel: 0844 844 9952
 Fax: 0844 844 9951
 Web: www.envirocheck.co.uk



Ordnance Survey Plan

Published 1984 - 1988

Source map scale - 1:10,000

The historical maps shown were reproduced from maps predominantly held at the scale adopted for England, Wales and Scotland in the 1840's. In 1854 the 1:2,500 scale was adopted for mapping urban areas; these maps were used to update the 1:10,560 maps. The published date given therefore is often some years later than the surveyed date. Before 1938, all OS maps were based on the Cassini Projection, with independent surveys of a single county or group of counties, giving rise to significant inaccuracies in outlying areas. In the late 1940's, a Provisional Edition was produced, which updated the 1:10,560 mapping from a number of sources. The maps appear unfinished - with all military camps and other strategic sites removed. These maps were initially overprinted with the National Grid. In 1970, the first 1:10,000 maps were produced using the Transverse Mercator Projection. The revision process continued until recently, with new editions appearing every 10 years or so for urban areas.

Map Name(s) and Date(s)

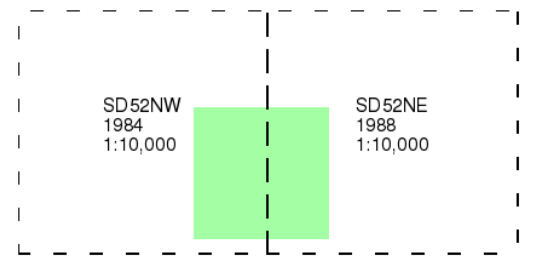

Historical Map - Slice C

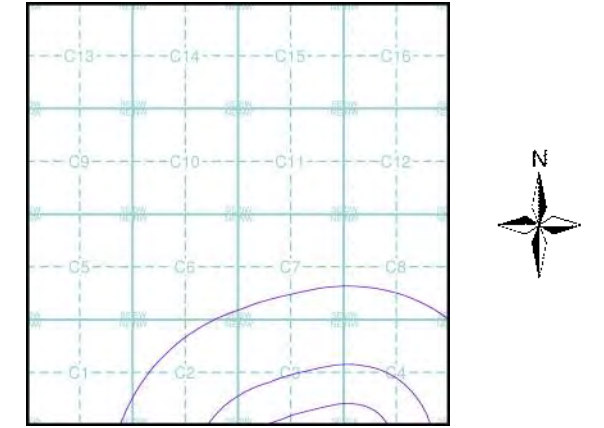

Order Details

Order Number: 289775268_1_1
 Customer Ref: WIE11556-107
 National Grid Reference: 355290, 425700
 Slice: C
 Site Area (Ha): 61.13
 Search Buffer (m): 1000

Site Details

Site at 355440, 424740

Ordnance Survey Plan

Published 1991

Source map scale - 1:10,000

The historical maps shown were reproduced from maps predominantly held at the scale adopted for England, Wales and Scotland in the 1840's. In 1854 the 1:2,500 scale was adopted for mapping urban areas; these maps were used to update the 1:10,560 maps. The published date given therefore is often some years later than the surveyed date. Before 1938, all OS maps were based on the Cassini Projection, with independent surveys of a single county or group of counties, giving rise to significant inaccuracies in outlying areas. In the late 1940's, a Provisional Edition was produced, which updated the 1:10,560 mapping from a number of sources. The maps appear unfinished - with all military camps and other strategic sites removed. These maps were initially overprinted with the National Grid. In 1970, the first 1:10,000 maps were produced using the Transverse Mercator Projection. The revision process continued until recently, with new editions appearing every 10 years or so for urban areas.

Map Name(s) and Date(s)

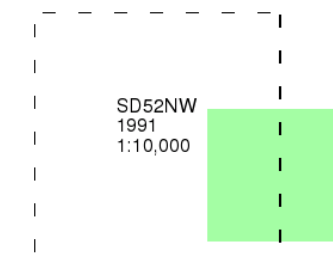

Historical Map - Slice C

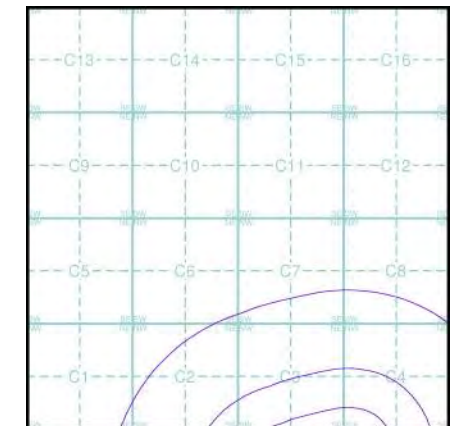

Order Details

Order Number: 289775268_1_1
Customer Ref: WIE11556-107
National Grid Reference: 355290, 425700
Slice: C
Site Area (Ha): 61.13
Search Buffer (m): 1000

Site Details

Site at 355440, 424740



10k Raster Mapping

Published 2001

Source map scale - 1:10,000

The historical maps shown were produced from the Ordnance Survey's 1:10,000 colour raster mapping. These maps are derived from Landplan which replaced the old 1:10,000 maps originally published in 1970. The data is highly detailed showing buildings, fences and field boundaries as well as all roads, tracks and paths. Road names are also included together with the relevant road number and classification. Boundary information depiction includes county, unitary authority, district, civil parish and constituency.

Map Name(s) and Date(s)

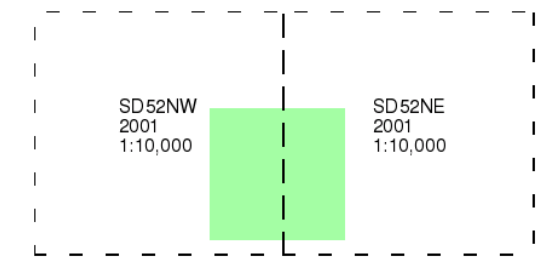

Historical Map - Slice C

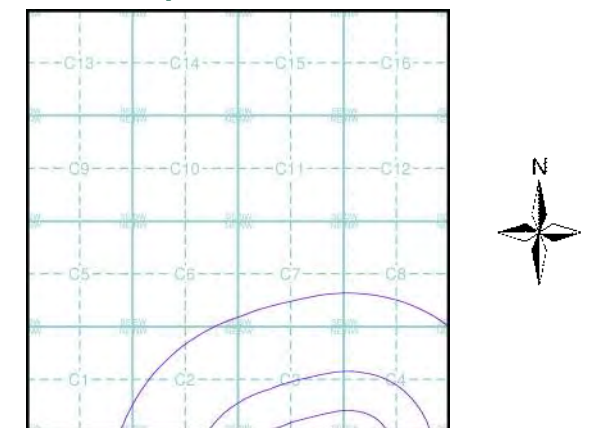

Order Details

Order Number: 289775268_1_1
 Customer Ref: WIE11556-107
 National Grid Reference: 355290, 425700
 Slice: C
 Site Area (Ha): 61.13
 Search Buffer (m): 1000

Site Details

Site at 355440, 424740



© Crown copyright. All Rights Reserved. Licence Number 100022432.



10k Raster Mapping
Published 2006
Source map scale - 1:10,000

The historical maps shown were produced from the Ordnance Survey's 1:10,000 colour raster mapping. These maps are derived from Landplan which replaced the old 1:10,000 maps originally published in 1970. The data is highly detailed showing buildings, fences and field boundaries as well as all roads, tracks and paths. Road names are also included together with the relevant road number and classification. Boundary information depiction includes county, unitary authority, district, civil parish and constituency.

Map Name(s) and Date(s)

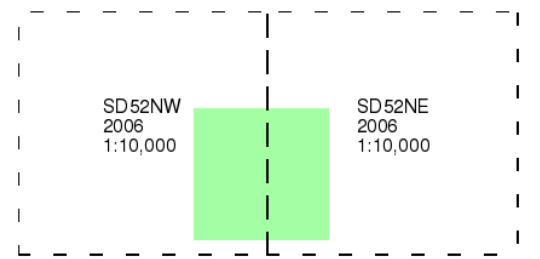

Historical Map - Slice C

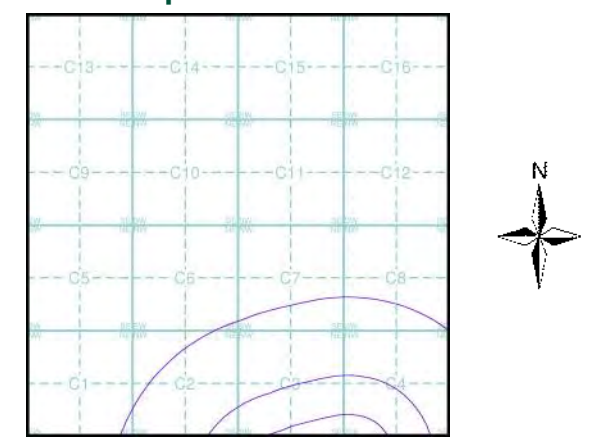

Order Details

Order Number: 289775268_1_1
 Customer Ref: WIE11556-107
 National Grid Reference: 355290, 425700
 Slice: C
 Site Area (Ha): 61.13
 Search Buffer (m): 1000

Site Details

Site at 355440, 424740

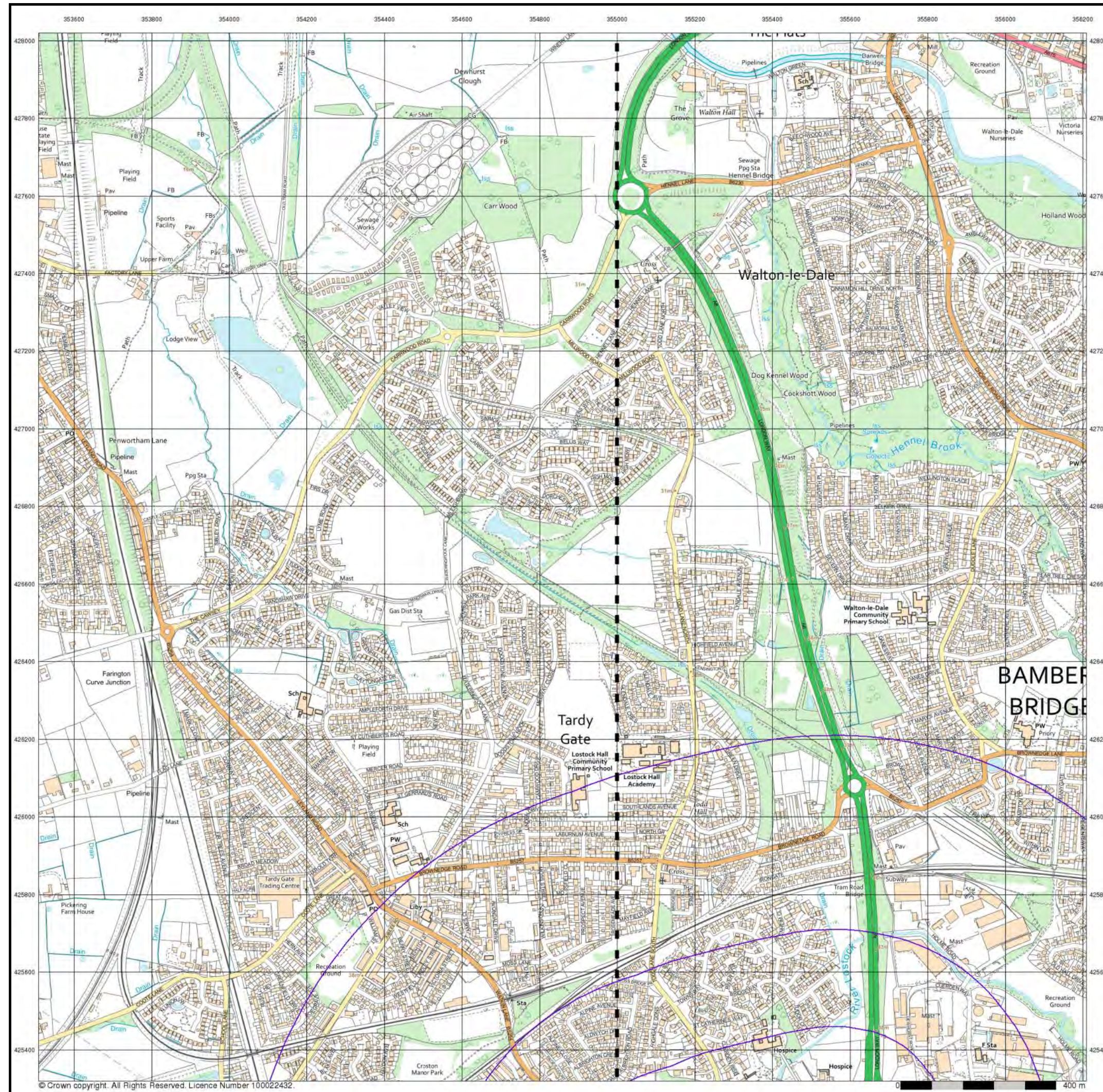

© Crown copyright. All Rights Reserved. Licence Number 100022432.

VectorMap Local
Published 2021
Source map scale - 1:10,000

VectorMap Local (Raster) is Ordnance Survey's highest detailed 'backdrop' mapping product. These maps are produced from OS's VectorMap Local, a simple vector dataset at a nominal scale of 1:10,000, covering the whole of Great Britain, that has been designed for creating graphical mapping. OS VectorMap Local is derived from large-scale information surveyed at 1:1250 scale (covering major towns and cities), 1:2500 scale (smaller towns, villages and developed rural areas), and 1:10 000 scale (mountain, moorland and river estuary areas).

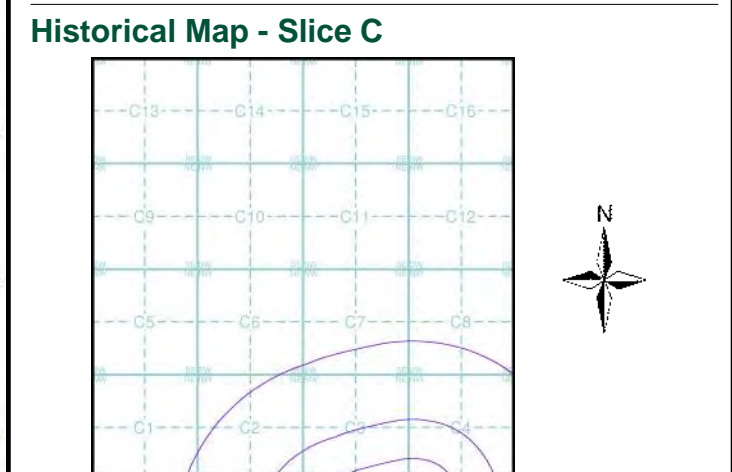
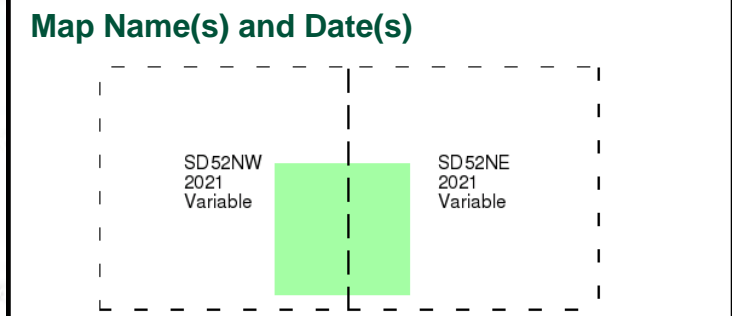

Order Details

Order Number: 289775268_1_1
 Customer Ref: WIE11556-107
 National Grid Reference: 355290, 425700
 Slice: C
 Site Area (Ha): 61.13
 Search Buffer (m): 1000

Site Details

Site at 355440, 424740